

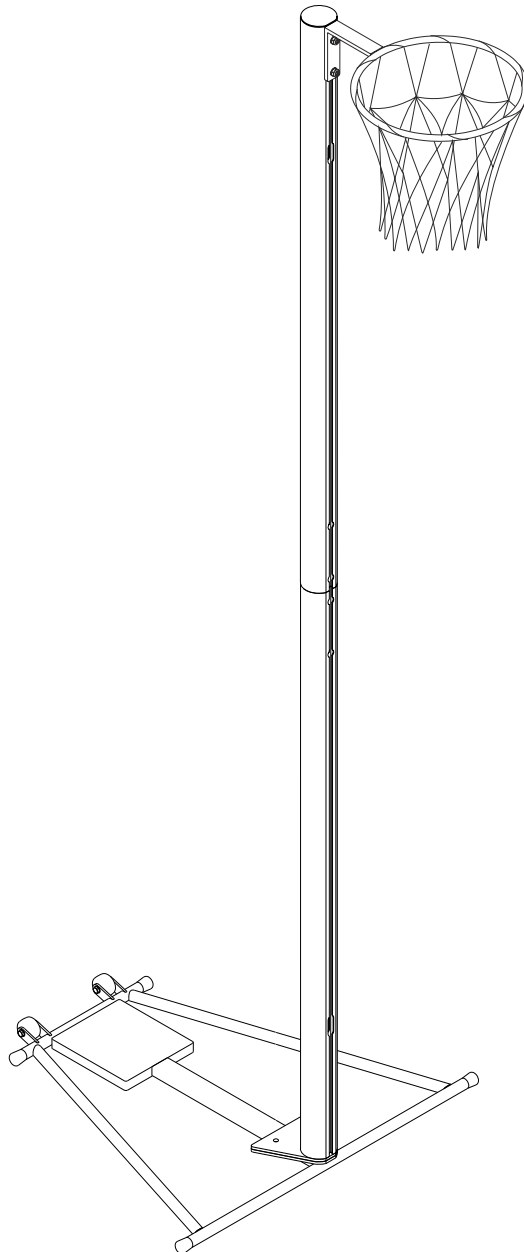



# FORZA

## FREESTANDING NETBALL POST AND BASE



**NET WORLD SPORTS»**

    @NetWorldSports

[www.networldsports.co.uk](http://www.networldsports.co.uk) // +44 (0) 1691 683 807 // [cs@networldsports.co.uk](mailto:cs@networldsports.co.uk)

[www.networldsports.com](http://www.networldsports.com) // 1-866-861-9095 // [cs@networldsports.com](mailto:cs@networldsports.com)

# PARTS LIST

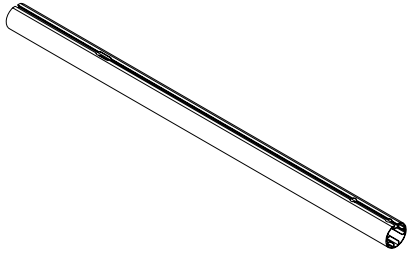

**PA45293.**  
**Post (x2)**

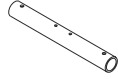

**PA45230**  
**Rail connector (x1)**

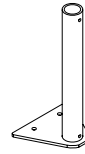

**PA45289**  
**Post connector (x1)**

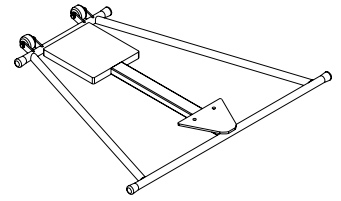

**PA45290**  
**Base (x1)**

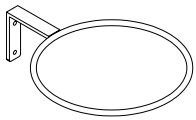

**PA45292**  
**Hoop (x1)**



**PA45288**  
**Rubber end cap (x1)**



**PA38220**  
**M8x55 bolt (x2)**



**PA45273**  
**M8x16 hex head bolt (x3)**



**PA38101**  
**M10x20 bolt (x2)**

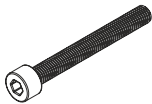

**PA45172**  
**M10x80 hex head bolt (x2)**



**PA45291**  
**M10x30 bolt (x2)**



**PA38115**  
**M10 lock nut (x6)**



**PA38122**  
**M10 Washer (X10)**



**PA38120**  
**M8 lock nut (x2)**



**PA38131**  
**M8 washer (x4)**



**PA38133**  
**M8 Spring washer (x3)**

# HANDY EXTRAS

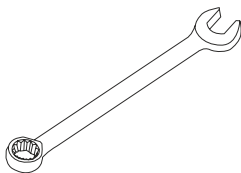

**Wrench**

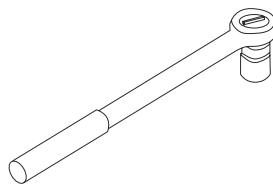

**Ratchet**

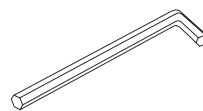

**Allen Key**

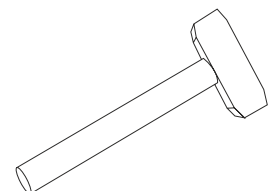

**Rubber mallet**

# **\*IMPORTANT\***

1. Read through the instructions thoroughly before assembling.
2. Installation, movement and use of equipment should be carried out under the supervision of a competent person using due diligence and risk assessment.
3. Take extreme care when installing, moving and lifting components.
4. Check all parts are present with no defects prior to the assembly.
5. Safety/warning stickers on the product must be visible at all times.
6. Never climb or swing on the product
7. We recommend lubricating/greasing the appropriate components (winders, sockets, inserts, nuts and bolts) to prolong lifespan.
8. Regularly inspect and maintain the equipment to ensure it is safe to use working correctly and to increase lifespan.

**2 people will be required to fit post to base**

## **Step 1. Assemble post.**

layout out the 2 post sections (PA45293) and the rail connector (PA45230). Slide the rail connector into one end of a post with 2 pre-drilled holes. Align both sets of pre-drilled holes and secure in place with 1 M10x80 (PA45172) hex bolt and M10 lock nut (PA38115) using M10 washers (PA38122) in between and 1 M8x16 hex bolt (PA45273) and spring washer (PA38133). See Fig.1.

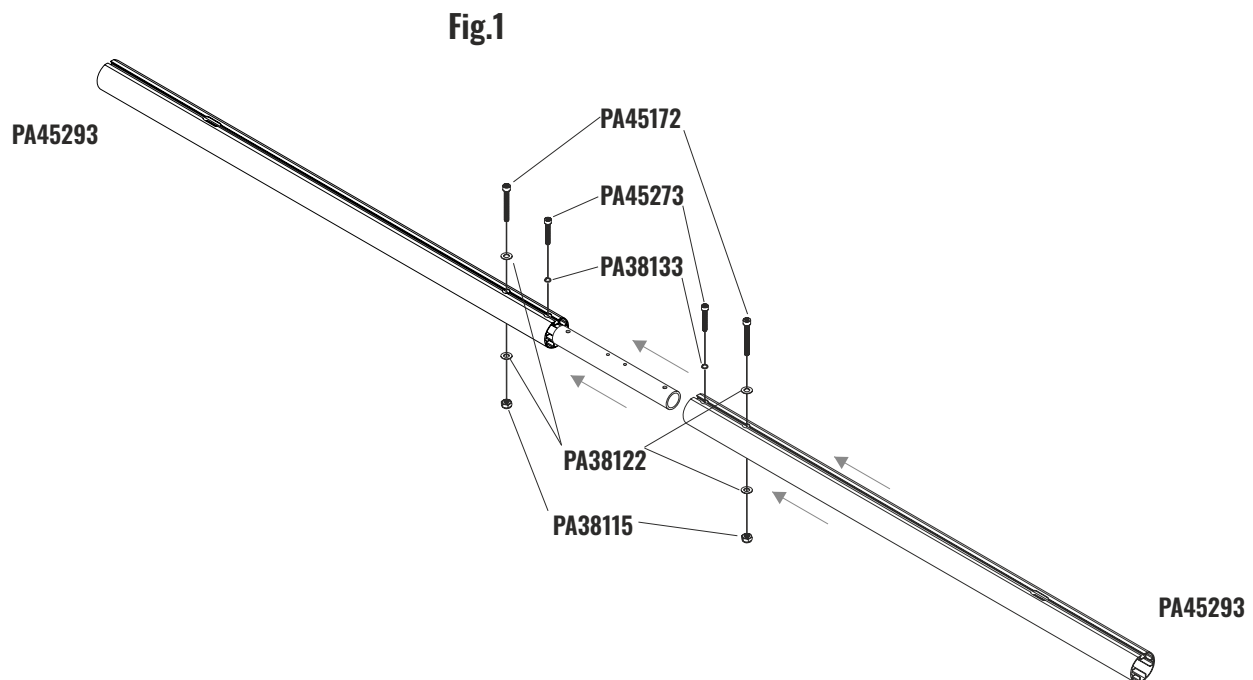

**Slide the 2nd post on to the rail connector and secure using same method as above.**

## Step 2. Fit hoop and End cap.

Slide 2 M10x20 (PA38101) bolts into the channel at 1 end of the assembled post, locate the hoop (PA45292) over the bolts and choose the required position. Once the Hoop is in position secure in place with M10 washers and M10 lock nut. Once hoop is attached tap rubber (PA45288) end cap into place with a rubber mallet. See Fig.2. and Fig.2a

Please note that the net should be attached the hoop at this point.

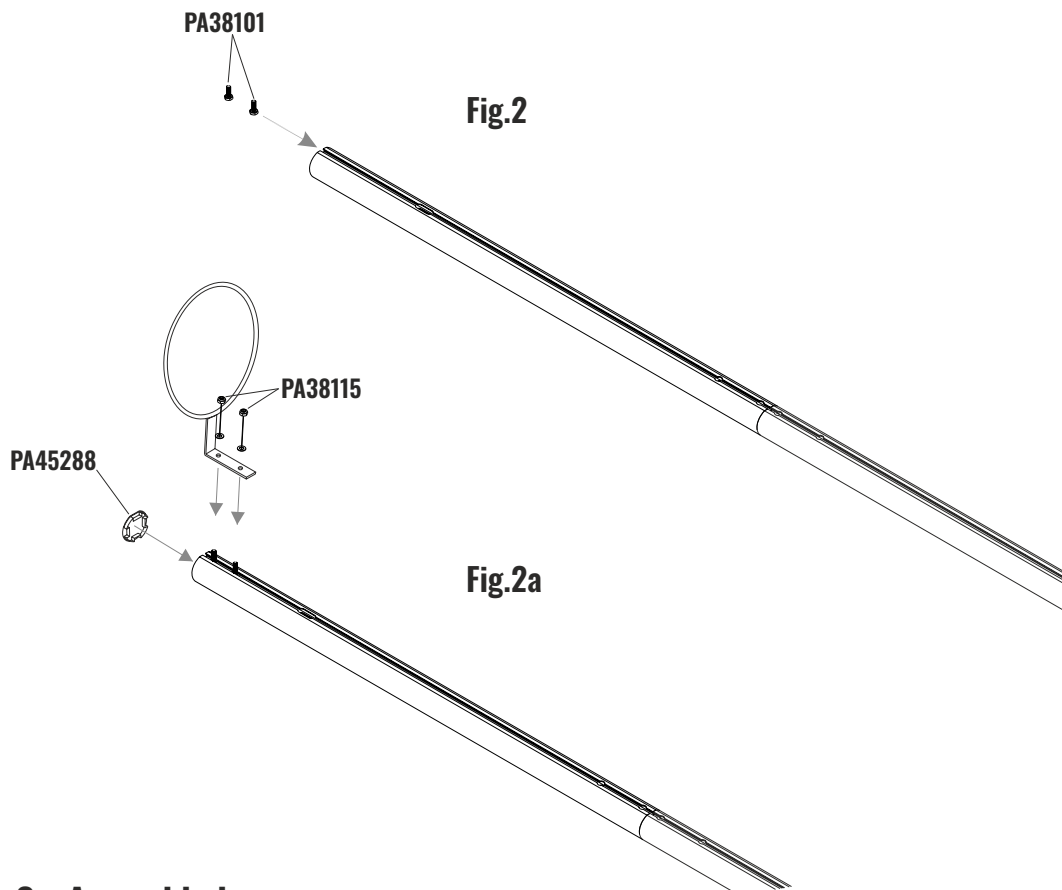

## Step 3 - Assemble base

Locate the post connector (PA45289) Over the fixing plate on the base, aligning the fixing holes. Secure in place with M10x30 bolt (PA45291), M10 washers and M10 nuts. See fig.3.

Fig.3

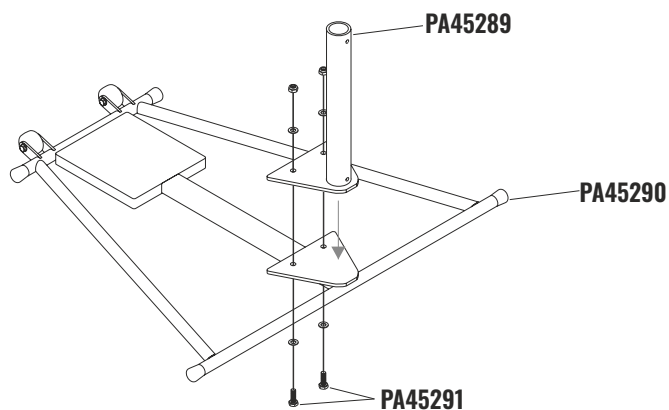

#### Step 4. Fit post.

Locate the assembled post over the post connector. Secure in place with M8x16 hex head bolt (PA45273) and spring washer. See fig.4.

